

REAR FACE OF BLOCK

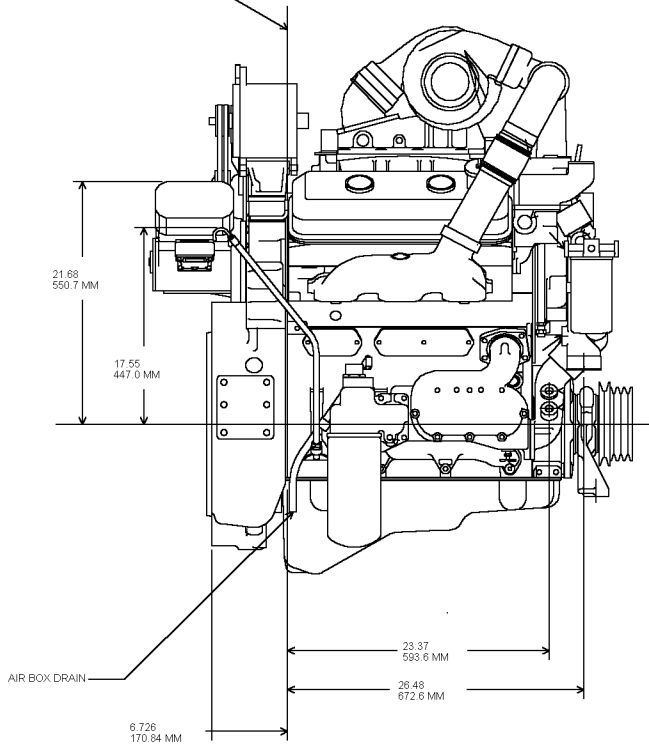

MODEL: 80677840

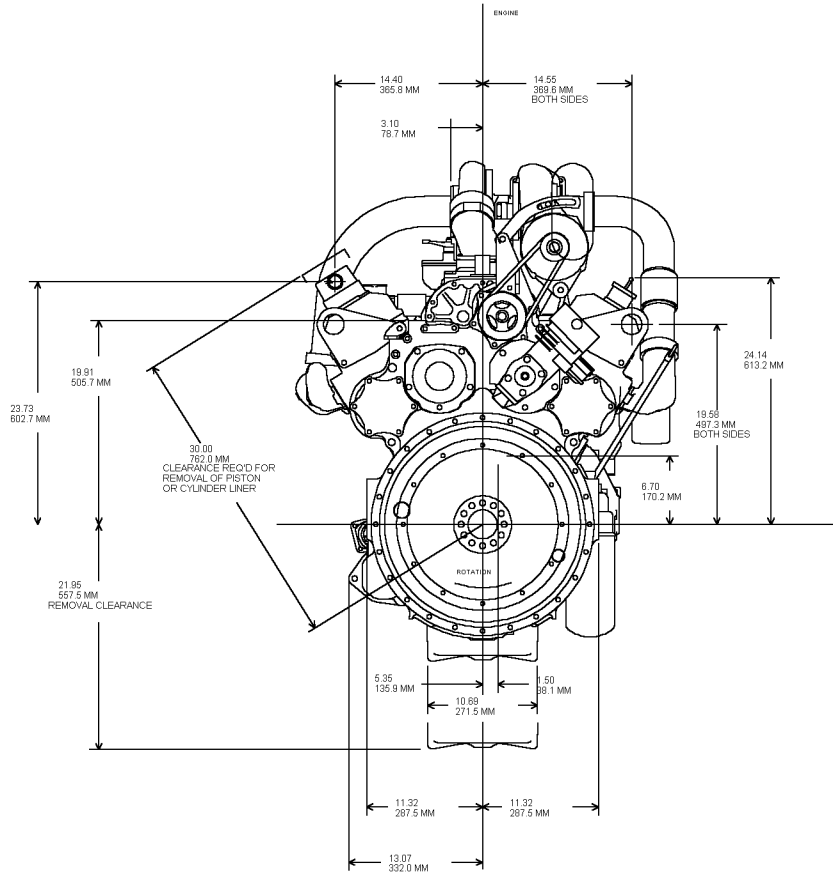

MODEL: 80677840

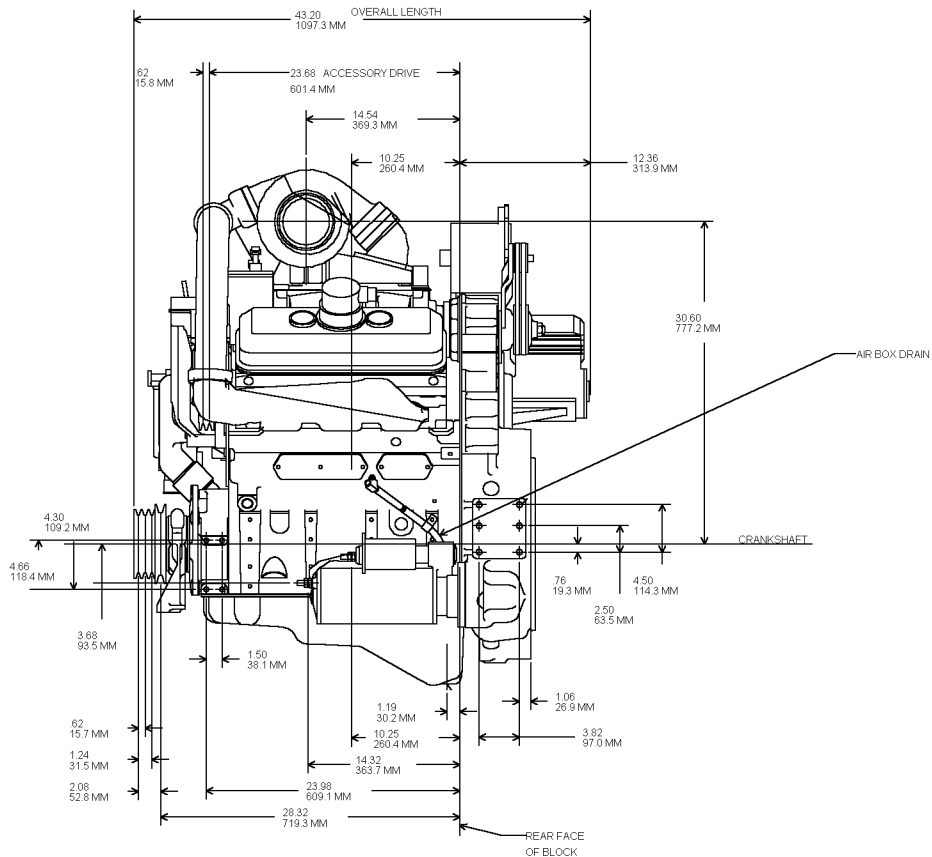

MODEL:80677840

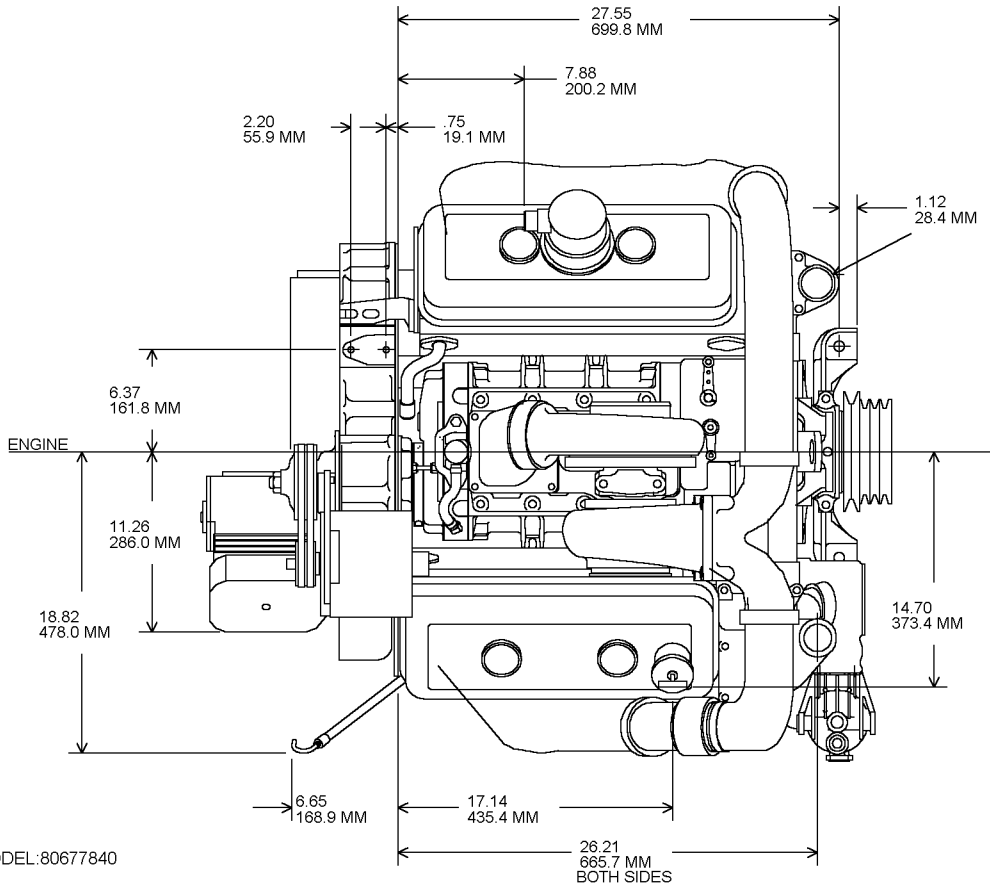

MODEL: 80677840



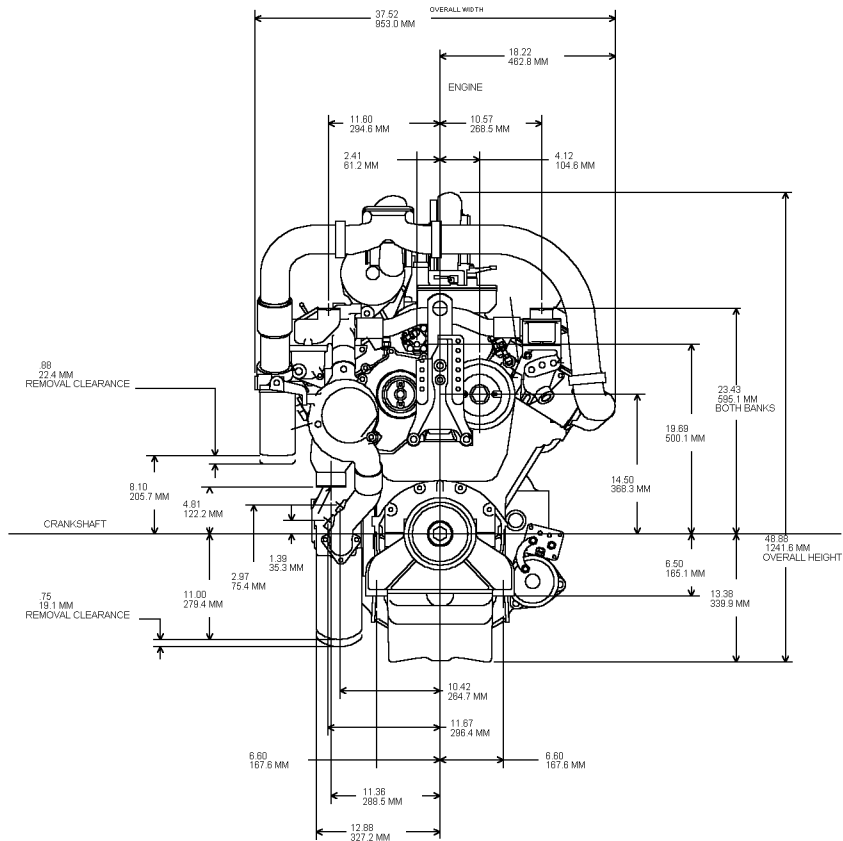

MODEL:80677840